

RTE for UNIX

SETUP MANUAL (Rev. 1.10)

REVISION HISTORY

Date	Revision	Chapter	Explanation of revision
December 20, 1996	1.00		First edition
May 5, 1998	1.10	1 2 5.1	<ul style="list-style-type: none">• Solaris 2.5.1(sparc) is added.• This chapter is added.• A note is added.

CONTENTS

1. INTRODUCTION	3
1.1 SETUP OVERVIEW	3
1.2 UNINSTALLATION OVERVIEW	3
2. SETUP PROCEDURE (Solaris 2.5.1 VERSION).....	4
2.1 MOUNTING A CD-ROM.....	4
2.1.1 <i>Mounting a Local CD-ROM Drive</i>	4
2.1.2 <i>Mounting a Remote CD-ROM Drive</i>	4
2.2 UNCOMPRESSING tar FILES.....	5
2.3 SETTING ENVIRONMENT VARIABLES.....	5
2.4 EJECT THE CD-ROM	5
2.4.1 <i>Eject the CD-ROM in a Local CD-ROM Drive</i>	5
2.4.2 <i>Eject the CD-ROM in a Remote CD-ROM Drive</i>	5
3. SETUP PROCEDURE (SunOS 4.1.x VERSION).....	4
3.1 MOUNTING A CD-ROM.....	4
3.1.1 <i>Mounting a Local CD-ROM Drive</i>	4
3.1.2 <i>Mounting a Remote CD-ROM Drive</i>	4
3.2 UNCOMPRESSING tar FILES.....	5
3.3 SETTING ENVIRONMENT VARIABLES.....	5
3.4 UNMOUNTING A CD-ROM DRIVE.....	6
3.4.1 <i>Unmounting a Local CD-ROM Drive</i>	6
3.4.2 <i>Unmounting a Remote CD-ROM Drive</i>	6
4. SETUP PROCEDURE (HP-UX 9.x VERSION).....	7
4.1 MOUNTING A CD-ROM.....	7
4.1.1 <i>Mounting a Local CD-ROM Drive</i>	7
4.1.2 <i>Mounting a Remote CD-ROM Drive</i>	7
4.2 UNCOMPRESSING tar FILES.....	8
4.3 SETTING ENVIRONMENT VARIABLES.....	8
4.4 UNMOUNTING A CD-ROM DRIVE.....	9
4.4.1 <i>Unmounting a Local CD-ROM Drive</i>	9
4.4.2 <i>Unmounting a Remote CD-ROM Drive</i>	9
5. OTHER SETTINGS AND CONFIRMATION OF OPERATION.....	10
5.1 SETTINGS (EXECUTING <code>setrte</code>)	10
5.2 CONFIRMATION OF OPERATION (EXECUTING <code>rte4unix</code>)	10
6. <code>setrte</code> COMMAND	12
6.1 SETTING	12
6.2 DISPLAYING THE CURRENT SETTINGS.....	12
7. SOFTWARE CONFIGURATION (Multi)	13

8. INTERNAL COMMANDS..... 14

1. INTRODUCTION

This manual describes how to set up RTE for UNIX. This software runs on an engineering workstation (EWS) and enables its connection to an RTE series ICE over a LAN. Three versions are available: for Solaris 2.5.1(sparc) (Sun Microsystems), for SunOS 4.1.x (Sun Microsystems) and for HP-UX 9.x (Hewlett Packard).

Hardware, called a LAN-BOX, is required to connect an RTE series ICE to an EWS over a LAN. The following diagram shows how to make this connection. Refer to the "LAN-BOX User's Manual" for details of the LAN-BOX.

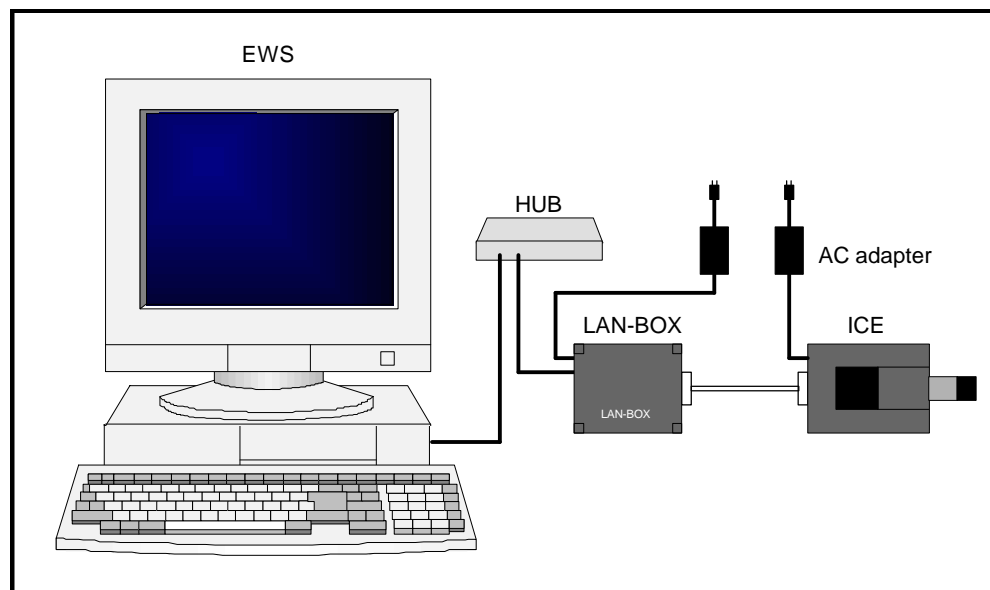

1.1 SETUP OVERVIEW

This section briefly describes how to set up RTE for UNIX. Before attempting to set up RTE for UNIX, first set up the LAN-BOX. (Refer to the "LAN-BOX User's Manual.")

- Mount the setup CD-ROM.
- Create a directory in which RTE for UNIX will be set up (hereafter called the RTE for UNIX program directory).
- Uncompress the files on the setup CD-ROM and copy them to the RTE for UNIX program directory, by using the tar command.
- Specify the "RTE4UNIX" environment variable.
- Execute setrte (to set up RTE for UNIX).
- Execute rte4unix (to confirm the connection with the LAN-BOX and conduct a simplified ICE test).

1.2 UNINSTALLATION OVERVIEW

RTE for UNIX can be uninstalled simply by erasing all the files from the RTE for UNIX program directory.

2. SETUP PROCEDURE (Solaris 2.5.1 VERSION)

This chapter describes how to set up RTE for UNIX under Solaris 2.5.1(sparc). See Chapter 5 for an explanation of the settings that must be made once this setup is complete.

2.1 MOUNTING A CD-ROM

The following sections explain how to mount the RTE for UNIX setup CD-ROM drive on an EWS in two different cases. In the first case, the RTE for UNIX setup CD-ROM drive is connected directly to the EWS on which the RTE for UNIX is to be set up (local connection). In the second case, the CD-ROM drive is connected to another EWS over a network (remote connection).

2.1.1 Mounting a Local CD-ROM Drive

Insert the RTE for UNIX setup CD-ROM into the CD-ROM drive, then the CD-ROM is mounted automatically.

In this example, the CD-ROM is mounted in the /cdrom directory.



If the CD-ROM is not mounted automatically, consult with your system administrator.

2.1.2 Mounting a Remote CD-ROM Drive

Mounting a CD-ROM drive connected to a remote EWS is done manually. Insert the RTE for UNIX setup CD-ROM into the CD-ROM drive, then key in the following commands from the respective EWSes.

In this example, the CD-ROM drive connected to the EWS for which the host name is rem_ews, is mounted automatically in the /cdrom directory of this EWS, then is mounted in the /mnt directory of the EWS for which the host name is loc_ews.

Commands entered via the rem_ews

```
/usr/sbin/exportfs -iv -o ro,access=loc_ews,root=loc_ews  
/cdrom/cdrom0
```

Command entered via the loc_ews

```
/sbin/mount -F nfs -r rem_ews:/cdrom/cdrom0 /mnt
```



rem_ews must be an NFS server, while loc_ews must be an NFS client. Contact your system administrator for details.



The exportfs command can be executed only from the root (superuser).



If the CD-ROM is not mounted automatically, consult with your system administrator.



The directories (in this example, /mnt) in which the CD-ROM drive is to be mounted must be created before the mount command is executed.



This example assumes that both rem_ews and loc_ews are using Solaris 2.5.1.





There is another method of mounting a CD-ROM drive. The cp and ftp commands can be used to transfer the setupxxx.tar file from the RTE for UNIX setup CD-ROM on the remote EWS to the local EWS.

2.2 UNCOMPRESSING tar FILES

This section describes how to create a directory in which RTE for UNIX is to be set up and how to extract the required files from the RTE for UNIX setup CD-ROM, by using the tar command.

In the following example, RTE for UNIX, copied from the CD-ROM mounted in the /cdrom directory, is set up in the /usr/local/rte4unix directory.

```
mkdir /usr/local/rte4unix
cd /usr/local/rte4unix
/bin/tar xvf /cdrom/cdrom0/sol2_5_1/setupsol.tar
```

-  **The user who executes the tar command becomes the owner of the uncompressed files.**
-  **Change the permission for the files as required.**

2.3 SETTING ENVIRONMENT VARIABLES

Following commands are entered to set the RTE4UNIX environment variable with the directory in which your RTE for UNIX is installed. The other command sets the PATH environment variable with the directory containing RTE for UNIX.

The following example assumes that RTE for UNIX is installed in /usr/local/rte4unix.

```
setenv RTE4UNIX /usr/local/rte4unix
setenv PATH /usr/local/rte4unix:$PATH
```



These setenv commands are always required when using RTE for UNIX. They should, therefore, be included in a shell start script such as .cshrc.

2.4 EJECT THE CD-ROM

Once the CD-ROM becomes unnecessary, it is ejected by means of the following procedure.

2.4.1 Eject the CD-ROM in a Local CD-ROM Drive

Key in the following commands.

```
/bin/eject cdrom0
```

2.4.2 Eject the CD-ROM in a Remote CD-ROM Drive

The CD-ROM is ejected from a remote CD-ROM drive two phases; the first phase is performed on the EWS on which RTE for UNIX has been set up, and the second is performed on the remote EWS.

This example unmounts a remote CD-ROM drive from the /mnt directory of the EWS for which the host name is loc_ews. Then, the CD-ROM is ejected from the CD-ROM drive of the EWS for which the host name is rem_ews.

Command executed on the loc_ews

```
/sbin/umount /mnt
```

Commands executed on the rem_ews

```
/usr/sbin/exportfs -u /cdrom/cdrom0  
/bin/eject cdrom0
```



The exportfs command can be executed only from the root (superuser).

3. SETUP PROCEDURE (SunOS 4.1.x VERSION)

This chapter describes how to set up RTE for UNIX under SunOS 4.1.x. See Chapter 5 for an explanation of the settings that must be made once this setup is complete.

3.1 MOUNTING A CD-ROM

The following sections explain how to mount the RTE for UNIX setup CD-ROM drive on an EWS in two different cases. In the first case, the RTE for UNIX setup CD-ROM drive is connected directly to the EWS on which the RTE for UNIX is to be set up (local connection). In the second case, the CD-ROM drive is connected to another EWS over a network (remote connection).

3.1.1 Mounting a Local CD-ROM Drive

Insert the RTE for UNIX setup CD-ROM into the CD-ROM drive, then key in the following command. In this example, the CD-ROM is mounted in the /mnt directory.

```
/usr/etc/mount -r -t hfs /dev/sr0 /mnt
```



The mount command can be executed only from the root (superuser).



"sr0" in "/dev/sr0" may vary depending on the SCSI-ID assigned to the CD-ROM drive (in this example, SCSI-ID = 6). If this sample command does not work, consult with your system administrator.



The directory (in this example, /mnt) in which the CD-ROM drive is to be mounted must be created before the mount command is entered.

3.1.2 Mounting a Remote CD-ROM Drive

Mounting a CD-ROM drive connected to a remote EWS is performed in two phases; the first phase on the remote EWS, and the second phase on the EWS on which your RTE for UNIX is to be set up.

Insert the RTE for UNIX setup CD-ROM into the CD-ROM drive, then key in the following commands from the respective EWSes.







In this example, the CD-ROM drive connected to the EWS for which the host name is rem_ews, is mounted in the /rem_mnt directory of this EWS, then in the /mnt directory of the EWS for which the host name is loc_ews.

Commands entered via the rem_ews

```
/usr/etc/mount -r -t hfs /dev/sr0 /rem_mnt  
/usr/etc/exportfs -iv -o ro,access=loc_ews,root=loc_ews /rem_mnt
```

Command entered via the loc_ews

```
/usr/etc/mount -r -t nfs rem_ews:/rem_mnt /mnt
```



-  **rem_ews must be an NFS server, while loc_ews must be an NFS client. Contact your system administrator for details.**
-  **The mount and exportfs commands can be executed only from the root (superuser).**
-  **"sr0" in "/dev/sr0" may vary depending on the SCSI-ID assigned to the CD-ROM drive. If this sample command does not work, consult with your system administrator.**
-  **The directories (in this example, /rem_mnt and /mnt) in which the CD-ROM drive is to be mounted must be created before the mount command is executed.**
-  **This example assumes that both rem_ews and loc_ews are using SunOS 4.1.x.**
-  **There is another method of mounting a CD-ROM drive. The cp and ftp commands can be used to transfer the setupxxx.tar file from the RTE for UNIX setup CD-ROM on the remote EWS to the local EWS.**

3.2 UNCOMPRESSING tar FILES

This section describes how to create a directory in which RTE for UNIX is to be set up and how to extract the required files from the RTE for UNIX setup CD-ROM, by using the tar command.

In the following example, RTE for UNIX, copied from the CD-ROM mounted in the /mnt directory, is set up in the /usr/local/rte4unix directory.

```
mkdir /usr/local/rte4unix
cd /usr/local/rte4unix
/bin/tar xvf /mnt/sun4_1/setupsun.tar
```

-  **The user who executes the tar command becomes the owner of the uncompressed files.**
-  **Change the permission for the files as required.**

3.3 SETTING ENVIRONMENT VARIABLES

Following commands are entered to set the RTE4UNIX environment variable with the directory in which your RTE for UNIX is installed. The other command sets the PATH environment variable with the directory containing RTE for UNIX.

The following example assumes that RTE for UNIX is installed in /usr/local/rte4unix.

```
setenv RTE4UNIX /usr/local/rte4unix
setenv PATH /usr/local/rte4unix:$PATH
```

-  **These setenv commands are always required when using RTE for UNIX. They should, therefore, be included in a shell start script such as .cshrc.**

3.4 UNMOUNTING A CD-ROM DRIVE

Once a CD-ROM drive becomes unnecessary, it is unmounted by means of the following procedure.

3.4.1 Unmounting a Local CD-ROM Drive

Key in the following commands.

In this example, the CD-ROM drive is unmounted from the /mnt directory, and the CD-ROM is ejected from the drive.

```
/usr/etc/umount /mnt  
/bin/eject /dev/sr0
```



The umount command can be executed only from the root (superuser).

3.4.2 Unmounting a Remote CD-ROM Drive

A CD-ROM drive is unmounted from a remote EWS in two phases; the first phase is performed on the EWS on which RTE for UNIX has been set up, and the second is performed on the remote EWS.

This example unmounts a remote CD-ROM drive from the /mnt directory of the EWS for which the host name is loc_ews and the CD-ROM drive from the /rem_mnt directory of the EWS for which the host name is rem_ews. Then, the CD-ROM is ejected from the CD-ROM drive.

Command executed on the loc_ews

```
/usr/etc/umount /mnt
```

Commands executed on the rem_ews

```
/usr/etc/exportfs -u /rem_mnt  
/usr/etc/umount /rem_mnt  
/bin/eject /dev/sr0
```



The umount and exportfs commands can be executed only from the root (superuser).

4. SETUP PROCEDURE (HP-UX 9.x VERSION)

This chapter describes how to set up RTE for UNIX under HP-UX 9.x. See Chapter 5 for details of the settings that must be made once this setup is complete.

4.1 MOUNTING A CD-ROM

The following sections explain how to mount the RTE for UNIX setup CD-ROM drive on an EWS in two different cases. In the first case, the RTE for UNIX setup CD-ROM drive is connected directly to the EWS on which RTE for UNIX is to be set up (local connection). In the second case, the CD-ROM drive is connected to another EWS over a network (remote connection).

4.1.1 Mounting a Local CD-ROM Drive

Insert the RTE for UNIX setup CD-ROM into the CD-ROM drive, then key in the following command. In this example, the CD-ROM is mounted in the /disc directory.

```
/etc/mount -r -t cdfs /dev/dsk/c201d2s0 /disc
```



The mount command can be executed only from the root (superuser).



"c201d2s0" in "/dev/dsk/c201d2s0" may vary depending on the SCSI-ID assigned to the CD-ROM drive (in this example, SCSI-ID = 2, where "2" corresponds to "2s0"). If this sample command does not work, consult with your system administrator.



The directory (in this example, /disc) in which the CD-ROM drive is to be mounted must be created before the mount command is entered.

4.1.2 Mounting a Remote CD-ROM Drive

The mounting of a CD-ROM drive connected to a remote EWS is performed in two phases; the first phase is performed on the remote EWS, while the second phase is performed on the EWS on which your RTE for UNIX is to be set up.

Insert the RTE for UNIX setup CD-ROM into the CD-ROM drive, then key in the following commands on the respective EWSes.

In this example, the CD-ROM drive connected to the EWS for which the host name is rem_ews is mounted in the /rem_disc directory of this EWS, then in the /disc directory of the EWS for which the host name is loc_ews.

Commands entered to rem_ews

```
/etc/mount -r -t cdfs /dev/dsk/c201d2s0 /rem_disc
/usr/etc/exportfs -iv -o ro,access=loc_ews,root=loc_ews /rem_disc
```

Command entered to loc_ews





```
/etc/mount -r -t nfs rem_ews:/rem_disc /disc
```



The rem_ews must be an NFS server, while the loc_ews must be an NFS client. Contact your system administrator for details.



The mount and exportfs commands can be executed only from the root (superuser).



-  "c201d2s0" in "/dev/dsk/c201d2s0" may vary depending on the SCSI-ID assigned to the CD-ROM drive (in this example, SCSI-ID = 2, where "2" corresponds to "2s0"). If this sample command does not work, consult with your system administrator.
-  The directories (in this example, /rem_disc and /disc) in which the CD-ROM drive is to be mounted must be created before the mount command is executed.
-  This example assumes that both rem_ews and loc_ews are using HP-UX 9.x.
-  There is another method of mounting a CD-ROM drive. The cp and ftp commands can be used to transfer the setupxxx.tar file from the RTE for UNIX setup CD-ROM on the remote EWS to the local EWS.

4.2 UNCOMPRESSING tar FILES

This section describes how to create a directory in which RTE for UNIX is to be set up and how to extract the required files from the RTE for UNIX setup CD-ROM, by using the tar command.

In the following example, RTE for UNIX from the CD-ROM mounted in the /disc directory is set up in the /usr/local/rte4unix directory.

```
mkdir /usr/local/rte4unix
cd /usr/local/rte4unix
/bin/tar xvf ' /disc/HPUX9/SETUPPHP.TAR;1'
```

-  The user who executes the tar command becomes the owner of the uncompressed files.
-  Change the permission for the files as required.

4.3 SETTING ENVIRONMENT VARIABLES

Following commands are entered to set the RTE4UNIX environment variable with the directory in which your RTE for UNIX is installed. The other command sets the PATH environment variable with the directory containing RTE for UNIX.

The following example assumes that RTE for UNIX is installed in /usr/local/rte4unix.

```
setenv RTE4UNIX /usr/local/rte4unix
setenv PATH /usr/local/rte4unix:$PATH
```

-  These setenv commands are always required when using RTE for UNIX. They should therefore be included in a shell start script such as .cshrc.

4.4 UNMOUNTING A CD-ROM DRIVE

Once a CD-ROM drive becomes unnecessary, it is unmounted by means of the following procedures.

4.4.1 Unmounting a Local CD-ROM Drive

Key in the following commands.

In this example, the CD-ROM drive is unmounted from the /disc directory, and the CD-ROM is ejected from the drive.

```
/etc/umount /disc
```



The umount command can be executed only from the root (superuser).

4.4.2 Unmounting a Remote CD-ROM Drive

A CD-ROM drive is unmounted from a remote EWS in two phases; the first phase is performed on the EWS on which RTE for UNIX has been set up, and the second phase is performed on the remote EWS.

This example unmounts the remote CD-ROM drive from the /disc directory of the EWS for which the host name is loc_ews and the CD-ROM drive from the /rem_disc directory of the EWS for which the host name is rem_ews.

Command executed on the loc_ews

```
/etc/umount /disc
```

Commands executed on the rem_ews

```
/usr/etc/exportfs -u /rem_disc  
/etc/umount /rem_disc
```



The umount and exportfs commands can be executed only from the root (superuser).

5. OTHER SETTINGS AND CONFIRMATION OF OPERATION

This chapter describes the settings that must be made once RTE for UNIX setup has been completed. It also explains how to confirm the operation of RTE for UNIX.

5.1 SETTINGS (EXECUTING `setrte`)

The `setrte` command is executed to specify the type of ICE to be used, as well as the IP address of the LAN-BOX.

The following example assumes that the ICE and LAN-BOX IP address are V853 and 192.168.1.1, respectively.

See Chapter 5 for details of the `setrte` command. Also refer to the "LAN-BOX User's Manual" for details of how to set up the address of the LAN-BOX.

```
setrte v853 192.168.1.1
```



The `/usr/local/rte4unix/.rte4unix` file is made by setting that used the `setrte` command. The permission of the write to this file must be given to all the users who use the `setrte` command.



The RTE4UNIX environment variable must be set up correctly, before the `setrte` command can be executed.



The `setrte` command **must be executed whenever the type of an ICE to be used or the IP address of the LAN-BOX is changed.** If a debugger is started without first executing the `setrte` command after the ICE type is changed, not only is normal operation hampered, but there is also a chance of a failure occurring.



The name assigned to the LAN-BOX may be specified as the LAN-BOX IP address in the `setrte` command. In this case, however, the LAN-BOX name must be registered with the DNS (domain name system) server.



The current settings can be displayed by entering: `setrte -s`



It is unnecessary to execute the `setrte` command every time the debugger is started. Instead, the debugger must be executed only once after the ICE type or LAN-BOX IP address has been changed.

5.2 CONFIRMATION OF OPERATION (EXECUTING `rte4unix`)

The `rte4unix` command is executed to confirm the operation of the LAN-BOX and ICE. Key in the following:

```
rte4unix -d
```

When command execution begins, the results are displayed. Confirm that "RTE functional test completed successfully." is displayed.

An example of the display at normal end is shown on the following page. This example assumes that a V853 ICE is being used.

```

rte4unix Version 1.11.0 Copyright (c) Midas lab, Inc. 1996 All rights
reserved.
RTE4UNIX=/usr/local/rte4unix
Connecting to 192.168.1.1
RTE Module Version 1.11.0, Dec 16 1996/12:04:06
CPU DLL Version 1.11.0, Dec 16 1996/12:04:14

Name=<V853> PCno=32 MaxReg=40 RegbufSize=160
F_Flag=00000020
Initialize RTE
Setting environment test
Memory fill test(Fill 0000 100 aa)
Memory read test(Read 0000 100)
Memory write test(Write 0200 10 11,12,....1f,20)
Memory read test(Read 0200 10)
Mapping test(Map 400000 1ff000 Target)
Mapping test(Map a00000 1000 Target)
Mapping list test
Memory write test(Write 0000 100 11,12,....1f,20)
Reset test
Setting BPS test(BPS 0020)
Setting BPH test(BPH 0030)
Setting PC test
Run test
Getting PC test
Delete BP test
Run test
Getting PC test
Delete BP test
Step test
Getting PC test
Step test
Getting PC test
Step test
Getting PC test
Step test
Getting PC test
Step test
Initialize RTE
RTE functional test completed successfully.

```



"rte4unix -d" will not work unless the setting made in the setrte command is correct.



If nothing is displayed following "Connecting to xxx.xxx.xxx.xxx," it is likely that the LAN-BOX IP address, specified with the setrte command, is incorrect. Alternatively, the IP address of the LAN-BOX or NET-MASK setting may be incorrect.



This is only an example. The actual version number and date are likely to differ from those in the example. In addition, the contents of the checks may vary with the type of the ICE being used.

6. setrte COMMAND

This chapter explains the setrte command. Entering the setrte command without specifying any arguments causes an abbreviated explanation of how to use the command to be displayed.

6.1 SETTING

Enter the setrte command, observing the following format:

setrte <ICE> <IP-ADDRESS>

ICE: Type of the ICE to be connected to the LAN-BOX. The ICE type could be, for example, v853 or v852. The supported ICE types can be displayed by entering the setrte command without any arguments.

IP-ADDRESS: IP address of the LAN-BOX. If your EWS is connected to a network in which a DNS (domain name system) is operating, and the LAN-BOX is registered with the DNS, the host name of the LAN-BOX can be specified instead of the IP address.

Example:

```
setrte v853 192.168.1.1
```



The setrte command does not check the IP address for validity. Use "rte4 unix -d" to validate the IP address setting.

6.2 DISPLAYING THE CURRENT SETTINGS

To display the current settings, enter the following:

```
setrte -s
```

7. SOFTWARE CONFIGURATION (Multi)

The following diagram shows the software configuration of RTE for UNIX, where the Green Hills Software Multi debugger is being used.

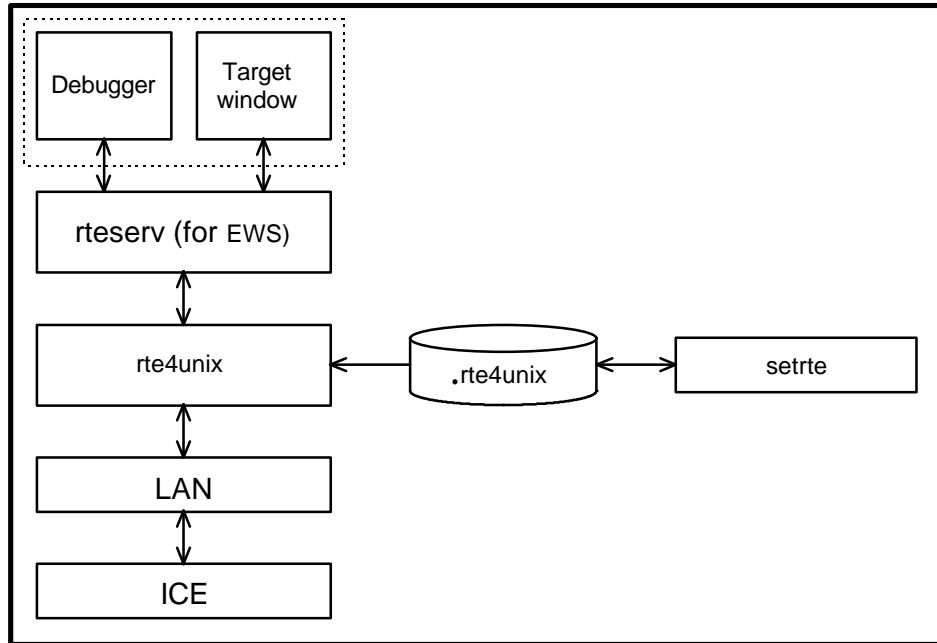

8. INTERNAL COMMANDS

Refer to the manual supplied with your ICE for details of the ICE internal commands that can be used as through commands with the debugger.

- Memo -